



Yealink CP965 Conference Unit

Phone + Voicemail

USER MANUAL



DECEMBER 2022

TABLE OF CONTENTS

CLICK ON ANY PAGE NUMBER TO RETURN TO THE TABLE OF CONTENTS

GENERAL INFORMATION	1
MAINTENANCE, BATTERY + POWER STATUS.	
HARDWARE - CONFERENCE UNIT FEATURES	2
UNDERSTANDING LIGHTS, KEYS + INDICATORS.	
SCREENS + ICONS	3
A QUICK REFERENCE GUIDE DEFINING SPECIFIC KEYS + FEATURES.	
NAVIGATING MENUS AND FIELDS	6
CALL PROCESSING	7
ANSWERING, PLACING CALLS, NAVIGATING CONNECTED CALLS, DO NOT DISTURB + CALL PARK.	
ESTABLISH A MULTI-PARTY CONFERENCE	8
STEPS TO CREATE AN ADHOC CONFERENCE	
CALL RECORDING	10
CALL HISTORY	11
INBOUND, OUTBOUND + MISSED CALL LOG	
DIRECTORY	12
LOCAL + NETWORK DIRECTORIES.	
CONNECT A MOBILE DEVICE	13
PAIR + CONNECT BLUETOOTH-ENABLED MOBILE PHONE.	
YOUR VOICEMAIL	15
LOGGING IN AND UNDERSTANDING COMMON VOICEMAIL COMMANDS.	



GENERAL INFORMATION

The Yealink IP Conference Phone CP965 uses the Android 9.0 operating system. It is perfect for any medium to large conference room. The Yealink CP965 provides wireless and wired pairing with your mobile staff – smartphone or PC/tablet via Bluetooth and USB Micro-B port.

MAINTENANCE

- + Clean the equipment with a soft, dry cloth. Never use liquids.

CP965 | FEATURES AT A GLANCE

GENERAL FEATURES

- + Android 9.0 OS
- + 5" capacitive touch screen
- + Black acoustics fabric, resistant to water/oil/stain

AUDIO FEATURES

- + Optimal HD audio
- + Yealink Noise Proof Technology, Smart Noise Filtering
- + 20-foot (6-meter) microphone pickup range
- + Built-in 12-microphone array for 360-degree voice pickup
- + Built-in microphone for noise cancellation
- + Full-duplex speakerphone with AEC

PHONE FEATURES

- + 10-way conference call
- + Analog PSTN calls via Yealink CPN10 (optional)
- + Supports DECT wireless expansion microphone CPW65

CONNECTIVITY

- + Built-in Bluetooth/Wi-Fi
- + Power over Ethernet (IEEE 802.3at), class 4
- + 1 USB 2.0 Type A port, 1 x USB 2.0 Type-C port

PHYSICAL LAYOUT

CP965 HARDWARE

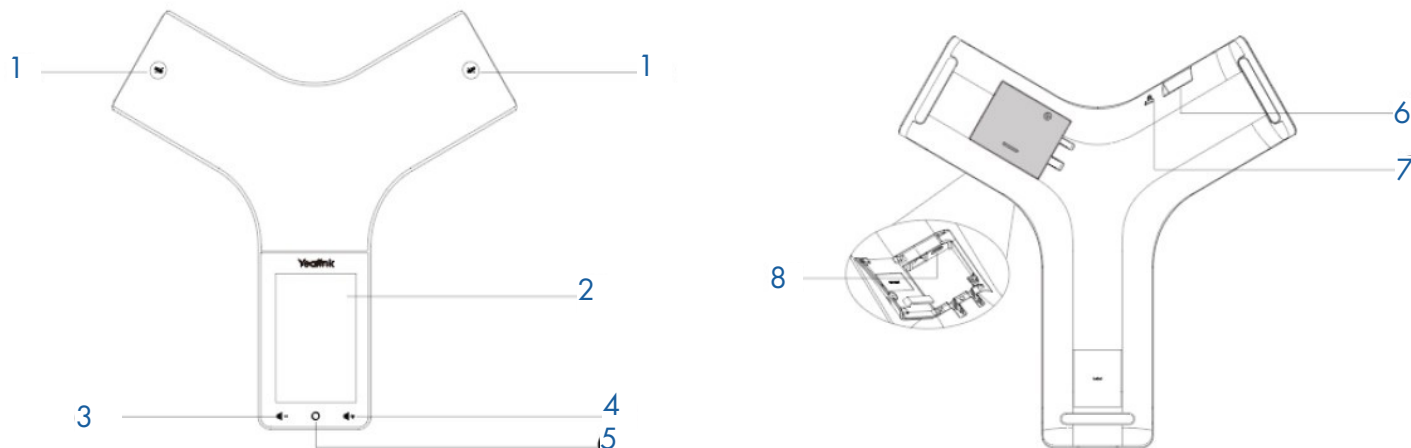

No.	Item	Description
1	Mute Touch Keys	+ Indicates phone status. + Toggles the mute feature on/off.
2	Touch Screen	+ Allows you to select items and navigate menus on the touch-sensitive screen. Tap to select items and navigate menus.
3	Volume Down (-) Key	+ Lowers the volume of the speaker, ringer, or media.
4	Volume Up (+) Key	+ Raises the volume of the speaker, ringer or media.
5	Home Touch Key	+ Returns to the idle screen.
6	USB Type-A Port	+ Allows you to connect a USB flash drive (optional) to your phone so you can record calls/conferences and play back recorded files. + Allows you to charge the Bluetooth Wireless Microphone CPW25 (Coming Soon) or DECT Wireless Microphone CPW65.
7	Security Slot	+ Allows you to connect a universal security cable to your phone so you can lock down your phone. The phone will not be removed after locked.
8	USB Type-C Port	+ Allows you to connect a PC and turn CP965 into an external speaker and microphone for your PC.

MUTE TOUCH KEY LED INDICATORS

The Mute touch key LED indicates the call and phone status.

LED Status	Description
Solid red	+ The phone is initializing + The phone is muted.
Flashing red	+ The phone is ringing.
Solid green	+ A call is being placed. + There is an active call on the phone.
Off	+ The phone is powered off. + The phone is idle.

SCREENS AND ICONS

The user screens and icon indicators help you navigate and understand the important information on the phone's status.

CONTROL CENTER AND NOTIFICATION CENTER

The control center or notification center allows you to access common features or view important notifications quickly. You cannot enter the control center or notification center during active calls, when the phone is ringing or when you are placing a call.

TO VIEW: Swipe down from the top of the screen.

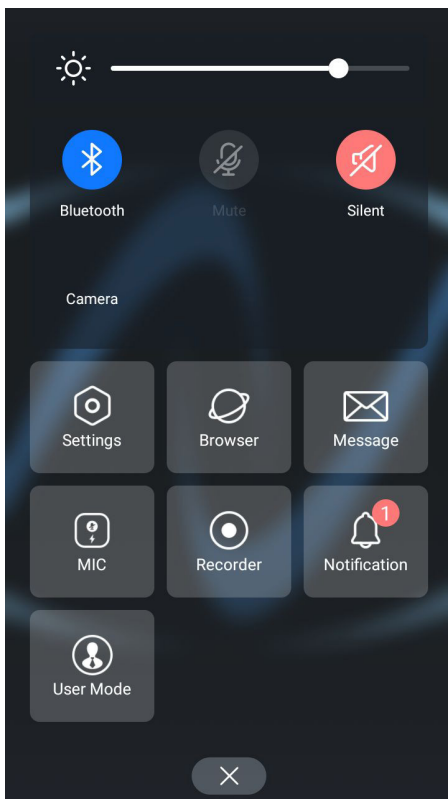

No.	LED Status	Description	
1	Control Center	Backlight Slider	+ Drag the slider to adjust the screen brightness.
		Wi-Fi	+ Tap to turn Wi-Fi on or off. + Long tap to enter Wi-Fi setting screen.
		Bluetooth	+ Tap to turn Bluetooth on or off. + Long tap to enter the Bluetooth setting screen.
		Mute	+ Tap to turn mute on/off.
		DND	+ Tap to turn DND on/off.
		Auto Answer	+ Tap to turn auto answer on/off.
		Silent	+ Tap to turn silent mode on/off.
2	Menu	Settings	+ Tap to enter the Settings menu.
		Browser	+ Tap to browse web pages.
		Message	+ Tap to enter the Message setting menu.
		MIC	+ Tap to enter the MIC setting menu.
		Recorder	+ Tap to use the Recorder to record audio and manage the recording.
		Notification	+ Tap to view notification messages.
		User Mode	+ Used by the system administrator and requires an Admin Password.

IDLE SCREEN

Your phone supports two idle screens by default. You can swipe left or right to switch between the idle screens.

NOTE: A third idle screen will appear if your system administrator customizes shortcut keys for you.

HOME SCREEN

The Home screen displays the registered account information, time and date and system applications.

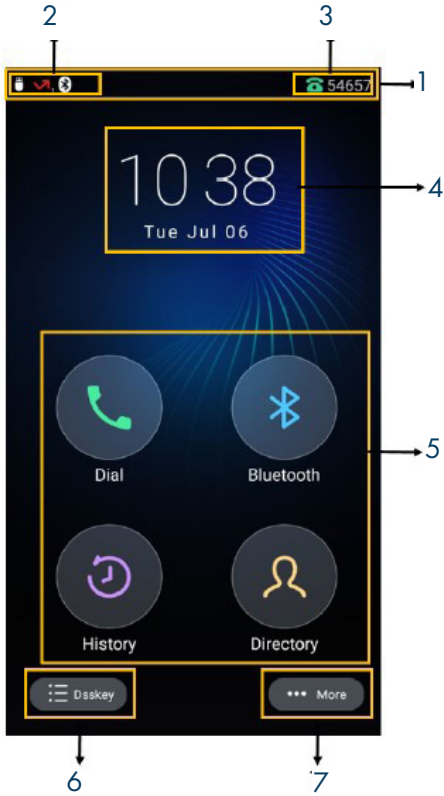

No.	LED Status	Description
1	Status Bar	+ Displays the label of the current account, icons and times.
2	Icons	+ Icons are displayed on the left of the status bar.
3	Current Account	+ Displays the current registered account. If there is no account registered on the phone, "No Service" is displayed.
4	Digital Clock Widget	+ Displays the phone's time and date.
5	Programmable Keys	Dial + Tap to enter the dial screen.
		Bluetooth + Tap to enter the Bluetooth settings screen.
		History + Tap to enter the History screen and view history records.
		Directory + Tap to enter the Directory screen and view contacts.
6	Dsskey	+ Tap to enter the Dsskey screen.
7	More	+ Tap to enter the Control Center.

DSSKEY SCREEN

The Dsskey screen displays the phone's line keys.

5

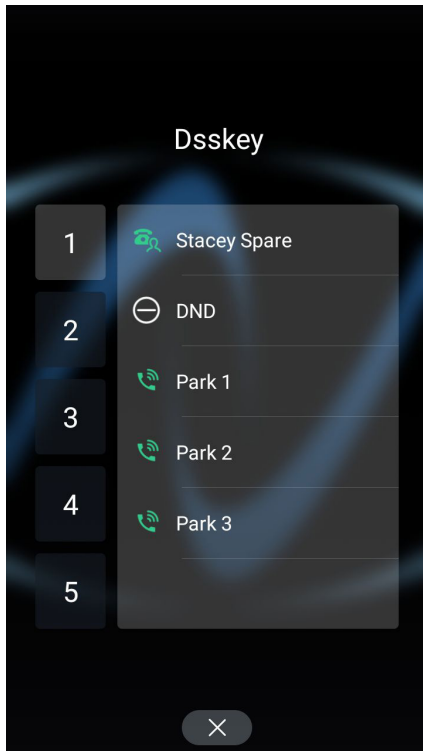

No.	LED Status	Description
1	Line Key List	+ Shows the line key labels. These can be customized by a System Administrator.
2	DND	+ Activates DND mode. Tap to activate/deactivate DND.
3	Park Keys	+ Used to place and retrieve calls on Park.
	X	+ Closes the Dsskey display.

CALLS SCREEN







All of your active and held calls are displayed on the Calls Screen. When there is an active call and a held call, the calls screen appear as below.



No.	Name	Description
1	Call Window	+ Displays all connected calls (both active and on hold).
2	Call Duration	+ Displays the duration of the connected call.
3	Hold	+ Places the active call on hold.
	Mute	+ Mutes the microphone.
	Invite	+ Begins the process to add another party to the call.
4	Keypad	+ Displays the active keypad.
5	End Call	+ Disconnects the active call.
	More	+ Displays additional commands.
	Previous/Next	+ Scrolls to additional connected calls.

NAVIGATING MENUS AND FIELDS

You can use different gestures on the touch screen to perform various operations. Use the tips below to help you navigate your screens.





Gesture		Action
Tap		Touch an item on the screen with your finger then lift your finger.
Long Tap		Touch and hold an item for two seconds without lifting your fingers from the screen until an action occurs.
Swipe		Touch and move. When you want to scroll quickly, swipe your finger across the screen - either up, down, left or right.
Drag		Touch and hold, then move. To stop scrolling, stop the dragging motion.
Pinch Open		Touch the screen with two or more fingers, and then move the fingers away from each other.
Pinch Close		Touch the screen with two or more fingers, and then move the fingers toward each other.

CALL PROCESSING



The Dialer enables you to enter a number to place a call. It also displays a list of previously placed calls or contacts in your directory.

PLACING AND ANSWERING CALLS

- TO PLACE CALL:** Tap .
OR Enter Number.
Tap **SEND.** 
- TO PLACE SECOND CALL:** Tap **MORE (...)** > **NEW CALL.** First call is placed on hold.
Enter the number or select from the directory and tap **SEND.**
- TO ANSWER CALL:** Hear Ringtone. Call information is displayed on the Screen. Tap **ANSWER.**
- TO SILENCE RINGING CALL:** Press .
- TO SEND TO VOICEMAIL:** Tap **REJECT.**
- TO ANSWER SECOND CALL:** Hear Call Waiting alert tone.
Tap **ANSWER.** First call is placed on hold and second call is connected.
- TO END CALL:** Tap **END CALL.**
- HOLD:** Tap **HOLD.**
- TO RECONNECT:** Tap **RESUME.**
- MUTE:** Tap **MUTE** on the touch screen or tap . The Mute key LED illuminates solid red.
- UNMUTE:** Tap  again. The Mute key LED illuminates solid green.
- TRANSFER:** Connect your call to someone else (with call on line)

Announced

- + Tap **MORE > TRANSFER** (call holds).
- + Enter the number to transfer to.
- + Tap **CALL.**
Wait for party to answer and announce call.
- + Tap **TRANSFER** again.

Blind

- + Tap **MORE > TRANSFER** (call holds).
- + Enter number.
- + Tap **TRANSFER.**
- + Tap **B TRANSFER.**

DO NOT DISTURB

Sends all calls to voicemail or provides a busy tone if there is no voicemail.

- TO ACTIVATE:** Swipe down from the top of the screen to enter the control center and toggle DND on.
or
Tap **Dsskey**.
Tap **DND**.
- When DND is enabled, the phone displays “**DND mode is enabled**” and the DND icon appears in the status bar.
- TO DEACTIVATE:** Select **EXIT DND MODE** from the idle screen.
or
Tap **Dsskey** and tap **DND**.

CALL PARK

Places an active call on a “system hold” so it can be retrieved from any telephone.



- TO PARK A CALL:** Tap **MORE > DSSKEY**.
Tap an available **PARK** Key.
- TO UNPARK:** Tap the applicable **PARK** Key.
Call is connected.

MULTI-PARTY CONFERENCE (Maximum of 4)

There are three ways to initiate a conference call on the CP965.

- + Initiate a conference by dialing multiple numbers.
- + Initiate a conference by inviting participants.
- + Initiate a conference by merging multiple calls together.

INITIATE A CONFERENCE CALL BY DIALING MULTIPLE NUMBERS

- + Tap 
- + Tap **CALL MULTIPLE MEMBERS? CLICK HERE >**.
- + Enter the number of the first party.
- + Tap **ADD MEMBERS** or select a contact.
The information appears at the top of the display.
- + Repeat the above steps to add all parties.
- + Tap  to call all the parties at once.
The conference is set when all parties answer the call.

Numbers to be added

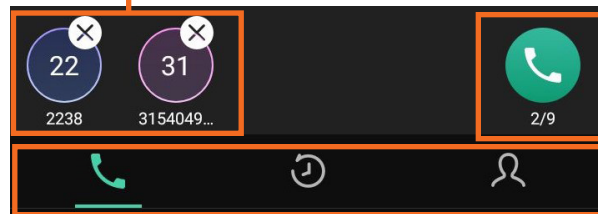

Tap to call all parties



Dialer, Call List and Contacts tabs

NOTE: The number below **CALL** indicates the number of parties you are connecting out of 9. A maximum of 10 parties, including yourself can be connected.

INITIATE A CONFERENCE CALL BY DIALING MULTIPLE NUMBERS

9

You can invite one or multiple parties at a time to join a conference call.

- + Place a call to the first party.
- + After the first part answers, tap **INVITE** .
- + Do one of the following:
 - + Enter the number of the second party and tap **INVITE**. Repeat the above step until you have added all intended parties.
 - or
 - + Select  to search contacts and select the contact you want to dial.
 - or
 - + Select  and to view history and select a party from your history record to dial.
 - or
 - + Select **CALL MULTIPLE MEMBERS? CLICK HERE >**. Enter the number or select the contact, then select **ADD MEMBERS**.

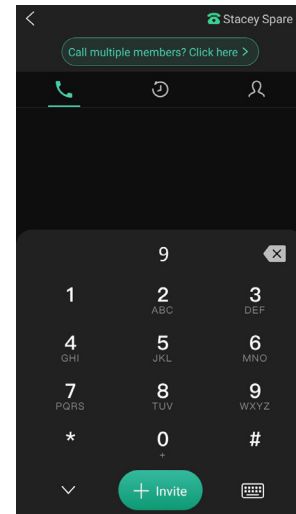
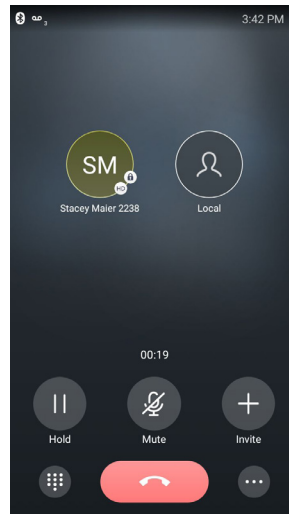

MERGE MULTIPLE CALLS INTO A CONFERENCE CALL

When you have multiple calls, you can merge them into a conference call.

- + Tap **MORE (...)** then tap **MERGE CALLS**. The calls are merged into a conference call.

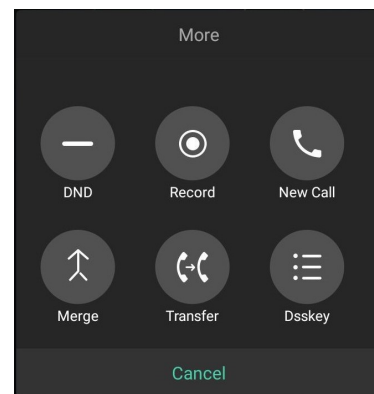

MANAGE CONFERENCE PARTICIPANTS

During the conference call, you can manage the participants. Tap on a conference participant to view the management tools.

- + **Mute a participant:** Tap **FAR MUTE** to mute a participant. They can still hear the other participants but cannot be heard.
- + **Hold a participant:** Tap **HOLD** to place a participant on hold.
- + **Remove a participant from the conference:** Select **REMOVE** to remove a participant from the conference permanently.
- + **Split a participant from the conference:** Select **SPLIT** to split the participant from the conference.
- + **View participant information:** Tap  to return to the conference screen and participant information.

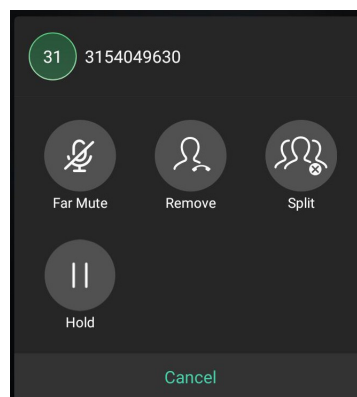

CALL RECORDING

You can record up to 12 hours in one file. By default, the recorded files are saved to the internal SD card. You can connect a USB flash drive to the phone and save the recorded audio to the connected USB flash drive.

IMPORTANT NOTE: Before recording it is necessary that you know the rules and restrictions of call recording for the state that you and others are in.

RECORD A CALL

- + During a call, tap **MORE > RECORD**.
- + If you have a USB Flash Drive inserted, select where to store the recording.
- + To end the recording, tap **MORE > STOP**.
The recording will end automatically when you end the call.
- + To mark a spot in the recording select **MARK**.

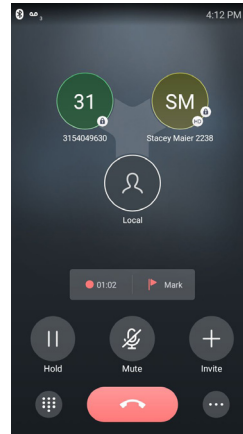

NOTES: You can record a conference call using the same method, but if the conference call is placed on hold, the recording is paused.

If the conference is placed on hold and you make another call, that call will be recorded in the same file.

CHECK STORAGE SPACE

You can check the total storage space and available storage space of the phone or connected USB flash drive.



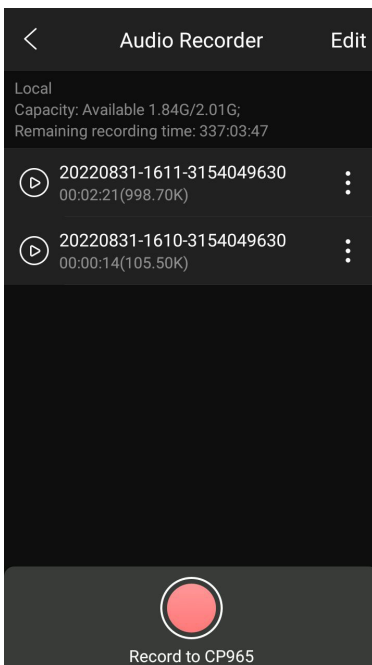

- + Tap **MORE > RECORDER** to launch the recorder application.
- + Select which device you want to check the storage on (Local or USB).
- + Storage and available recordings are displayed for the device.



CALL HISTORY

The Call History list displays all of the phones recent calls including missed, placed, received and forwarded calls. Each list holds 10 entries. The history record saves the call information such as the caller's name and number and call duration.

CALL HISTORY ICONS

ICON	DESCRIPTION	ICON	DESCRIPTION
	Received Call		Missed Call
	Placed Call		Forwarded Call

VIEW CALLS

+ Tap HISTORY.



+ Tap INFORMATION to view call details.

SAVE HISTORY RECORD TO YOUR LOCAL DIRECTORY

+ Tap HISTORY.

+ Tap INFORMATION.

+ Tap ... > ADD TO CONTACT.

+ Edit any applicable information.

+ Tap NEXT.

+ Tap DONE.

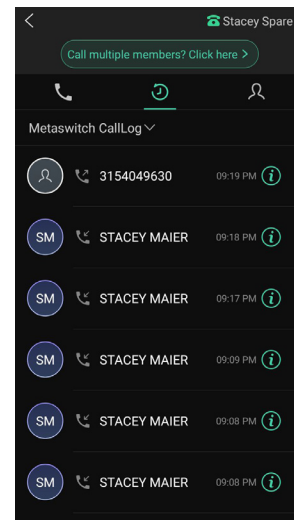

PLACE A CALL FROM HISTORY

+ Tap HISTORY.

+ Tap the desired entry to call the number.

DIRECTORY

There are two types of directories included in the **PHONE BOOK**:



- + **LOCAL:** Numbers you can program into your telephone. You can store up to 1000 entries in your local directory.
- + **NETWORK:** Entries stored by the system administrator to be used by all users, including internal extensions.

ADD ENTRIES TO LOCAL DIRECTORY

- + Tap .
- + Tap .
- + Enter the contact's information.
- + Select an account.
- + Select a photo if desired.
- + Tap **DONE**.

NOTE: You can also add numbers to your local directory through the CommPortal Web interface. See the CommPortal User Manual at www.northland.net/support for how to.

SEARCH FOR CONTACTS

- + Tap .
- + Tap .
- + Enter the search criteria in the search field.
- + Select the desired letter from the right side to jump to contacts whose names (first or last) begin with that letter.

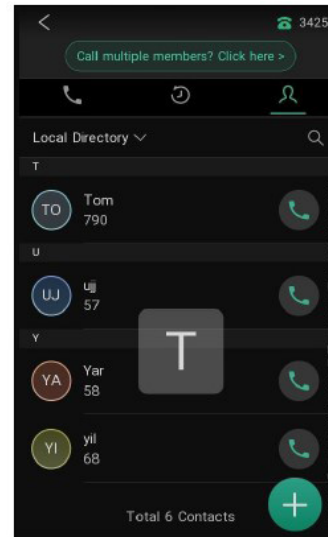

PLACE A CALL FROM THE DIRECTORY

- + Tap .
- + Select the applicable directory.
- + Tap the desired contact.
If the desired contact has multiple numbers listed, select the applicable number to complete the call.

PAIR AND CONNECT A BLUETOOTH-ENABLED MOBILE PHONE

You can pair and connect a Bluetooth-enabled mobile phone with the CP965 phone. You can pair multiple mobile devices but only one can be connected at a time. After connecting them, You can:

- + Make and receive mobile calls on the phone.
- + Use the phone as a Bluetooth speaker for music on your mobile phone.
- + Merge the calls on your phone, the PC and connected mobile phone into a hybrid UC Conference Call.

NOTE: Not all mobile phones support this feature. Contact your system administrator for more information.

ACTIVATE THE BLUETOOTH MODE

- + Swipe down from the top of the screen.
- + Tap  .
or
- + Tap **MORE > SETTINGS > BLUETOOTH.**
- + Turn on Bluetooth.
The phone automatically scans the available Bluetooth devices in your area.
The Bluetooth icon appears in the status bar.

PAIR AND CONNECT BLUETOOTH-ENABLED MOBILE PHONE

ENABLE CP965 PHONE AUDIO

When you enable the phone audio, the phone can act as a speaker and microphone for your connected mobile phone. The call is made through your mobile phone but the audio is present on the Yealink phone and the call is controlled by the Yealink phone.

TO PAIR

Make sure that the Bluetooth-enabled mobile phone is discoverable.

- + Tap **MORE > SETTINGS > BLUETOOTH.**
- + Select  to search for the mobile phone.
- + Tap the desired Bluetooth-enabled phone.
- + Select **PAIR** on both the mobile phone and the CP965.

NOTE: The connection will be completed successfully when a prompt appears under the Bluetooth-enabled mobile phone number.

HANDLE A MOBILE CALL ON THE CP965

The CP965 will act as a handsfree speaker and microphone for your mobile device.

The call information appears on both the CP965 and the mobile phone screen. You can control the call's audio to go through the mobile phone or the CP965.

- + Choose Bluetooth to direct audio to the CP965.
- + Choose Handset earpiece or speaker to direct the audio to the mobile phone.

TO CONFIGURE PHONE AUDIO FEATURE

- + Tap **MORE > SETTINGS > BLUETOOTH**. The phone automatically searches for available devices.
- + Tap  after the desired Bluetooth enabled mobile phone name.
- + Select **MOBILE CONTACT SYNC** If you wish to sync your contacts.

TO PLACE A CALL

- + At the top of display, tap the name.
- + Tap **MOBILE LINE**.
- + Place a call

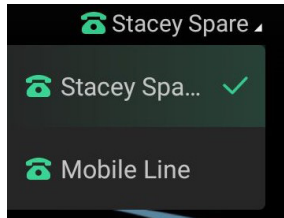

TO ANSWER A CALL

An incoming call to your mobile phone will also display on the Yealink phone.

- + Tap **ANSWER**.

During the call you can hold/resume, mute/unmute or end the call from the Yealink phone.

DISCONNECT THE BLUETOOTH DEVICE

You can disconnect the paired Bluetooth device from the phone. When you disconnect a Bluetooth device, it remains paired and you can reconnect it to your phone.

- + Select the Bluetooth icon.
- + Tap the connected phone.
- + Tap **OK**.

DEACTIVATE BLUETOOTH MODE

After you deactivate the Bluetooth mode, the Bluetooth device will disconnect from the phone, but it remains paired and you can reconnect it.

- + Tap the Bluetooth Icon.

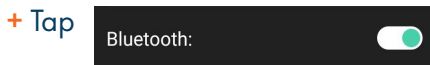

VOICEMAIL

The voicemail system is voice prompted with easy to follow instructions and commands. You must initialize your mailbox for the first time by creating a password, recording your name and recording a greeting.

FIRST TIME VOICEMAIL SET UP

To set up your voicemail for the first time:

- + Dial *99.
- + Enter the EAS Pin provided by the System Administrator.
- + Follow the audio instructions to create a password, record your name and record your personal greeting.

MAILBOX GREETINGS

There are multiple greeting types available for you to choose from:

PERSONAL	Plays to everyone that calls you.
EXTENDED ABSENCE	Plays when you will be away from your office or phone for meetings/vacation, etc. You can turn off message acceptance when using the extended absence greeting. System will remind you Extended Absence Greeting is playing.
SYSTEM GENERATED	A synthesized greeting. This can be set up to include your telephone number or recorded name.
BUSY	Plays when you have active calls on all available lines.
OUT OF HOURS	Can be set to play outside of your normal business hours, weekends and holidays.
FORWARDED TO VM	Plays when you have your phone set to forward to voicemail.

Through the Self Service CommPortal, you are able to:

- + Record and change greetings.
- + Choose your voicemail to email options.
- + Change your login for voicemail so you are not required to enter your mailbox and pin each time you log in from your own telephone.
- + Change other voicemail and telephone settings.

Please refer to the Self Service CommPortal User Guide on the Northland Communications website for full details.

LOG IN TO VOICEMAIL

From any internal extension:

- + Dial *99.
- + Enter your 10 digit telephone number and press the # key
- + Enter your password and press the # key

From any external telephone:

- + Dial: 315-671-0031
- + Enter your 10 digit telephone number and press the # key
- + Enter your password and press the # key

COMMON VOICEMAIL COMMANDS

Main Menu

- 1 Listen to messages
- 2 Send a message to another user
- 3 Work with personal greetings
- 4 Mailbox settings
- 5 Work with Reminder Messages
- 6 Access deleted messages
- 7 Switch Account (log into another account)
- 0 Access Help
- * Exit Voicemail or return to previous menu

NOTES: Star (*) will always back you up to the previous menu
 Pound (#) will bypass a user’s personal greeting

Listening to Messages

- 1 Repeat
- 2 Save
- 3 Erase
- 4 Reply
- 5 Send a copy
- 6 Increases the message volume
- 7 Slows the message playback down
- 8 Pause / Resume
- 9 Speeds the message playback up
- # Next Message
- 11 Previous Message
- 77 Skip backward 5 seconds
- 99 Skip forward 5 seconds

ADDITIONAL VOICEMAIL SETTINGS

There are additional voicemail settings available in the main menu. Some settings are only available when you log in through a telephone. See the CommPortal User Guide for settings that are available through CommPortal.

WORK WITH GREETING SETTINGS

From the Main Menu, press 3 to work with Greetings. The following greeting settings are available.

- Press 1 to work with the personal greeting
- Press 2 to work with the extended absence greeting
- Press 3 to choose a system generated greeting or to work with your recorded name
- Press 5 to work with the greeting that plays when your phone is busy
- Press 6 to work with your out of hours greeting (this allows to set a schedule for a greeting that plays outside of your normal business hours). See also the CommPortal User Guide.
- Press 9 to work with the greeting callers hear when your phone is set to forward all calls to voicemail

WORK WITH TIMESAVER AND CONVENIENCE SETTINGS

From the Main Menu, press 4 to work with Settings. The following settings are available.

- Press 1 to work with group lists - add / edit / delete group lists.
- Press 2 to work with timesaver settings - turn autoplay on / off, work with Urgent Message settings and change your message header and body settings.
- Press 3 to work with Security – change the pin, set fast login or set skip pin.
- Press 5 to work with Notifications - message waiting indicator, email notifications and phone notifications.
- Press 6 for Additional Settings - Check the Operator number or turn Marketing broadcasts on / off.
- Press 0 to hear helpful hints.

TRANSFER TO VOICEMAIL: Sends a caller directly to voicemail without ringing the phone.

- + Tap **MORE > TRANSFER** (call holds).
- + Enter *99 and Extension Number.
- + Tap **TRANSFER**.
- + Tap **B TRANSFER**.

LEAVE A MESSAGE FOR ANOTHER USER WITHOUT RINGING THE PHONE:

- + Press *99
- + Enter Extension Number and tap **CALL**.